

# Owners & Installation

# Masport®

## G51 Surefire

Models: G51-NG  
G51-LPG

# Manual



### PLEASE KEEP THESE INSTRUCTIONS FOR FUTURE REFERENCE

**WARNING:**

Improper installation, adjustment, alteration, service or maintenance can cause injury or property damage. Refer to this manual. For assistance or additional information consult an authorised installer, service agency or the gas supplier.

**FOR YOUR SAFETY**

Do not store or use gasoline or other flammable vapours and liquids in the vicinity of this or any other appliance.

Installation and service must be performed by an authorised installer, service agency or the gas supplier.

**FOR YOUR SAFETY**

What to do if you smell gas:

- Do not try to light any appliance
- Do not touch any electrical switch: do not use any phone in your building.
- Immediately call your gas supplier from a neighbour's phone. Follow the gas supplier's instructions.
- If you cannot reach your gas supplier, call the fire department.

**LISTINGS AND CODE APPROVALS**

These gas appliances have been tested in accordance with AG 103, NZS 5262 and have been certified by the Australian Gas Association for installation and operation as described in these Installation and Operating Instructions.

Your unit should be serviced annually by an authorised service person.

Australia  
P.O. Box 533  
Braeside, Victoria 3195

New Zealand  
1-37 Mt Wellington Hwy. Panmure,  
P.O. Box 14349  
Auckland 6.

---

## TO THE NEW OWNER:

Congratulations!

You are the owner of a state-of-the-art Gas Stove by FPI FIREPLACE PRODUCTS INTERNATIONAL LTD. The G51 has been designed to provide you with all the warmth and charm of a wood fireplace at the flick of a switch.

The G51 has been approved by the Australian Gas Association for both safety and efficiency. As it also bears our own mark, it promises to provide you with economy, comfort and security for many trouble free years to follow. Please take a moment now to acquaint yourself with these instructions and the many features of your Masport Fireplace.



# TABLE OF CONTENTS

---

## Safety Label

Safety Label .....	4
--------------------	---

## Installation

Unit Dimensions .....	5
Important Message .....	6
For Your Safety .....	6
Gas Pipe Testing .....	6
Before You Start .....	6
Installation Checklist .....	6
Materials Required .....	6
Minimum Fireplace Dimensions .....	7
Minimum Clearances to Combustibles .....	7
Gas Connection .....	7
Flueing .....	8
Gas Pressure Test .....	8
Test for Flue Spillage .....	8
Gas Aeration System .....	8
Installation of Flue Gather .....	8
Valve Tray Installation .....	9
Burner Installation .....	10
Log Set Installation .....	11
Finishing Trim Installation .....	14
Brick Panel Installation .....	14
Screen Installation (Optional) .....	15
Wiring .....	16

## Operating Instructions

Operating Instructions .....	17
Lighting Procedure .....	17
Shutdown Procedure .....	17
First Fire .....	17
Normal Operating Sounds of Gas Appliances .....	17
Lighting Plate Instructions .....	18

## Maintenance

Maintenance Instructions .....	19
Log Replacement .....	19
Fan Replacement .....	20
Replacement Parts List .....	21

## Warranty

Warranty .....	23
----------------	----

# SAFETY LABEL

This is a copy of the label that accompanies each G51 Gas Fireplace.

**NOTE:** Masport units are constantly being improved. Check the label on the unit and if there is a difference, the label on the unit is the correct one.

## Masport Gas Fireplace

Model	○
<b>Gas Type</b>	<b>NG</b>
Model	<b>G51-NG</b>
Gas Consumption	50mj.
Manifold Pressure	0.79kPa
Injector Size	1x#29 3.45mm
AGA Approval number to Code AG103	6547

Distributed by:

**Masport Pty. Ltd.**  
PO Box 533  
Braeside, Victoria. 3195

**Masport Ltd.**  
1-37 Mt. Wellington H/Way  
Auckland 6  
New Zealand

To be installed by an authorised person in accordance with installation instructions provided with the appliance.

Flue cowl size is 200mm.

Electrical: 240VAC 50Hz 1.0 amp max.



Serial Number 258

918-258a



- DO NOT** OPERATE THIS APPLIANCE BEFORE READING THE INSTRUCTIONS BOOKLET.
- DO NOT** PLACE ARTICLES ON OR AGAINST THIS APPLIANCE
- DO NOT** STORE CHEMICALS OR FLAMMABLE MATERIALS, OR SPRAY AEROSOLS NEAR THIS APPLIANCE.
- DO NOT** OPERATE WITH PANELS, COVERS OR GUARDS REMOVED FROM THIS APPLIANCE.
- DO NOT** ENCLOSE THIS APPLIANCE.

908-602

**THE GUARD IS FITTED TO THIS APPLIANCE TO REDUCE THE RISK OF FIRE OR INJURY FROM BURNS AND NO PART OF IT SHOULD BE PERMANENTLY REMOVED.**



**FOR PROTECTION OF YOUNG CHILDREN OR THE INFIRM, A SECONDARY GUARD IS REQUIRED.**

(Australia Only)

# UNIT DIMENSIONS

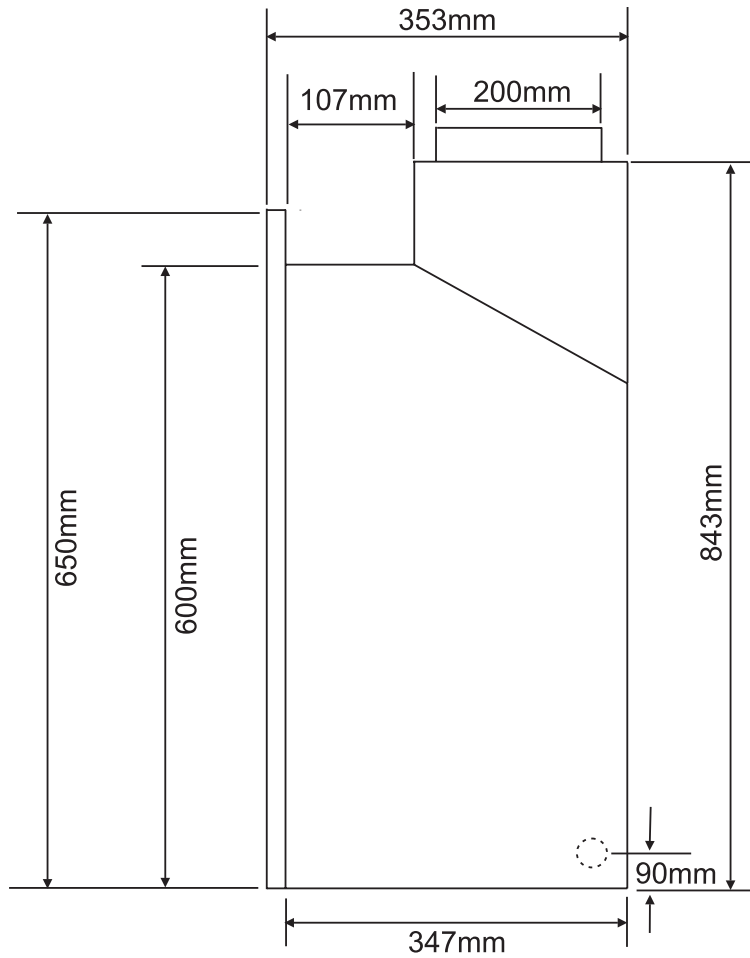
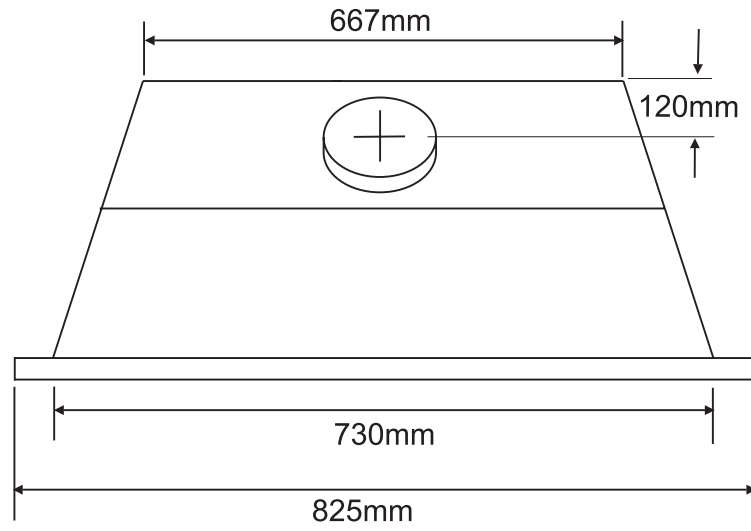

# INSTALLATION

---

## IMPORTANT: SAVE THESE INSTRUCTIONS

The Masport Gas Fireplace must be installed in accordance with these instructions. Carefully read all the instructions in this manual first.

**Note:** Failure to follow these instructions could cause a malfunction of the heater which could result in death, serious bodily injury, and/or property damage. Failure to follow these instructions may also void your fire insurance and/or warranty.

---

## FOR YOUR SAFETY

This appliance requires air for proper combustion. Always provide adequate combustion and ventilation air. Follow instructions and information in the current AG 601, NZS 5261 or local codes. Consult the "authority having jurisdiction" to determine the need for a permit prior to starting the installation.

---

## GAS PIPE TESTING

The appliance must be isolated from the gas supply piping system by closing its individual manual shutoff valve during any pressure testing of the gas supply piping system at test pressures equal to or less than 3.45 kPa.

### Specifications:

Fuel: NG or LPG

Electrical: 240 volt 50 hz system

Fan/Blower: 2-speed, 127 CFM

Log Sets: Ceramic fibre

## BEFORE YOU START

Installation is to be carried out **ONLY** by an authorised person.

- 1) The appliance shall be installed in accordance with the manufacturer's installation instructions, local gas fitting regulations, municipal building codes, water supply regulations, electrical wiring regulations, with AG 601 (AGA gas installation code) NZS 5261 (New Zealand).
- 2) Installation and repair should be done **ONLY** by an authorised person.
- 3) The appliance should be inspected before use and at least annually by an authorised service person. More frequent cleaning may be required due to excessive lint from carpeting, bedding material, etc. It is imperative that control compartments, burners and circulating air passageways of the appliance be kept clean and free from excessive lint from carpeting.
- 4) See general construction and assembly instructions. This appliance may only be installed in a flued, non-combustible fireplace. The appliance and flue should be enclosed when installed or passing through a living area, where children may come in contact with it. **For combustible enclosure use zero clearance Kit # 390-900.**
- 5) Always connect this space heater to a chimney and flue to the outside of the building envelope. Never flue to another room. Make sure that the flue is properly sized and is of adequate height to provide the proper draft.
- 6) Inspect the flueing system annually for blockage and any signs of deterioration.
- 7) To prevent injury, do not allow anyone who is unfamiliar with the operation to use the fireplace.

## INSTALLATION CHECKLIST

The Masport Gas Insert is installed as listed below.

- 1) Unit Location - check Clearances to Combustibles on page 7.
- 2) Make the gas connections, see page 8.
- 3) Install flue gather to unit, see page 8.
- 4) Install flue pipe to gather collar.
- 5) Install valve tray and burner, see pages 9-10.
- 5) Test gas pressure, page 8. Check aeration, page 8.
- 6) Test for flue spillage, page 8.
- 7) Install the optional brick panels. See page 14.
- 8) Install the log set. See page 11.
- 9) **Final check:** Before leaving this unit with the customer, the installer must ensure that the appliance is firing correctly. This includes:
  - a) Clocking the appliance to ensure the correct firing rate.
  - b) Adjusting the primary air, if required, to ensure that the flame does not carbon.
  - c) Ensuring that the appliance is flueing correctly.

---

## MATERIALS REQUIRED

No electric power supply is required for the gas control to operate. A 240 Volt AC power cord is hooked up to the fan switch and blower. Plug 3 wire cord into a suitable receptacle. Do not cut the ground terminal off under any circumstances.

When connected with 240 volts, the appliance must be electrically grounded in accordance with local codes.

# INSTALLATION

## MINIMUM FIREPLACE DIMENSIONS

The minimum fireplace dimensions for the Masport gas space heater are shown in the following diagrams:

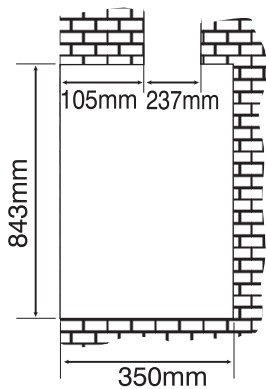
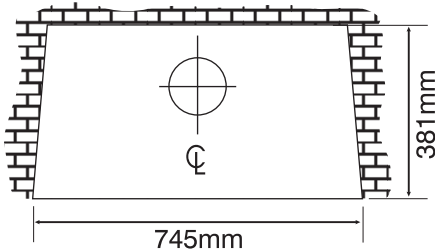

## MINIMUM CLEARANCES TO COMBUSTIBLES

The minimum fireplace clearances for the Masport gas space heater are shown in the following diagrams:

	From Unit	
Sides	A	305 mm
Ceiling	B	914 mm
Mantle	C	318 mm
Floor	H	100 mm
Min. Alcove Width	K	1435 mm
Max. Alcove Depth	L	915 mm
Mantle	D	305 mm

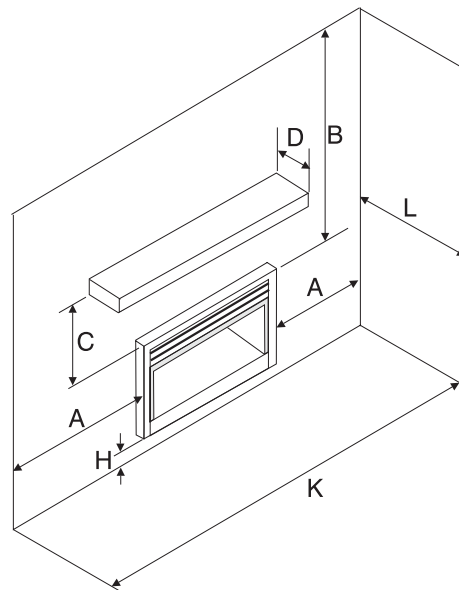

**NOTE:** A non-combustible mantel may be installed at a lower height if the framing is made of metal studs covered with a non-combustible board.

## GAS CONNECTION

**GAS CONNECTION WARNING:**  
Only persons licensed to work with gas piping may make the necessary gas connections to this appliance.

- 1) If the appliance is to be installed into an existing chimney system, thoroughly clean the masonry or factory built fireplace.
- 2) The gas line should be rigid pipe. Copper may also be used if approved by AG 601.

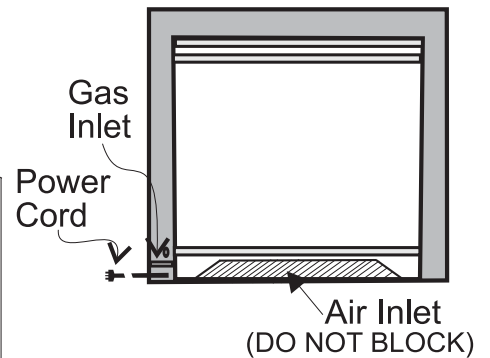

- 3) Locate the center point where the flue will pass through the chimney above the appliance. Move the appliance into the exact location where it is to be installed. Ensure that the Insert is level.

SPECIFICATIONS	
	NG
INJECTOR SIZE	#29 3.45mm
INPUT RATING	Min. 25 mj/h Max. 50 mj/h
MANIFOLD PRESSURE	Max. 0.79 kPa

# INSTALLATION

## FLUEING

**THE APPLIANCE MUST NOT BE CONNECTED TO A CHIMNEY FLUE SERVING A SEPARATE SOLID FUEL BURNING APPLIANCE.**

This appliance is designed to attach to a 200 mm diameter type B-Vent or listed gas fuel type vent liner running the full length of the chimney. A minimum flue height of 3.6 m. is recommended.

Periodically check that the flue is unrestricted and an adequate draft is present when the unit is in operation.

Before installing flue system ensure that the damper plate is open and secure to prevent the damper plate from falling down and crushing the liner.

Install to AG 601 (Australia), NZS 5261 (New Zealand).

### Combustion and Ventilation Air

**WARNING: This appliance needs fresh air for safe operation and must be installed with provisions for adequate combustion and ventilation air available to the room in which it is to be operating.**

Air for combustion is drawn in through the front of the unit, therefore, the front of the unit must be kept clear of any obstructions.

## GAS PRESSURE TEST

The unit is preset to give the correct gas input at the specified manifold pressures shown on the label. The maximum gas manifold pressure is:

NG      0.79 kPa

The pressure check should be carried out with the unit burning and the setting should be within the limits specified.

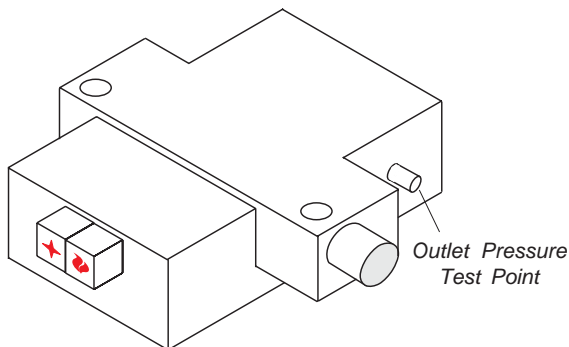

## TEST FOR FLUE SPILLAGE

**A "spillage" test must be made before the installed unit is left with the customer. Follow the procedure below:**

- 1) Start all exhaust fans in the home and then close all external doors and windows in the house.
- 2) Light the unit and set controls to maximum. Turn fan off.
- 3) After five minutes, test that there is a "pull" on the flue by placing a smoke match, cigarette or similar device which gives off smoke, in position as shown.

**Light a match close to centre. Check if smoke is drawn inside flue.**

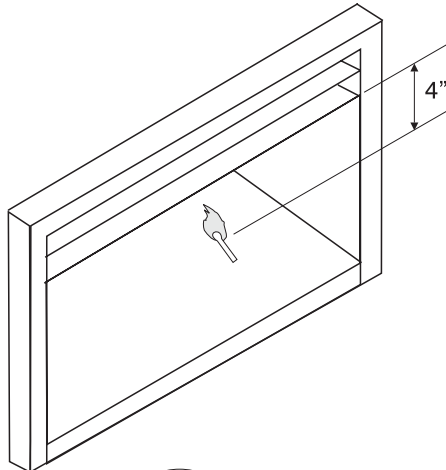

downdraft or block flue

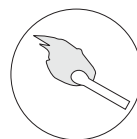

normal draft

Diagram 1

## GAS AERATION SYSTEM

The aeration adjustment rod is attached to the air shutter which is located just above the orifice bracket. The rod is used to adjust the aeration on the main burner without having to take the appliance apart.

The burner aeration is factory set but may need adjusting due to either the local gas supply, air supply or altitude. This adjustment is performed by the installer. (Pull the rod for a more yellow flame, or push the rod to make the flame bluer.)

NG:                      5 mm open

**Note: Any damage due to carboning resulting from improperly setting the aeration controls is NOT covered under warranty.**

## INSTALLATION OF FLUE GATHER

- 1) Line up flue gather with the holes on the firebox.
- 2) Secure in place with 16 screws.

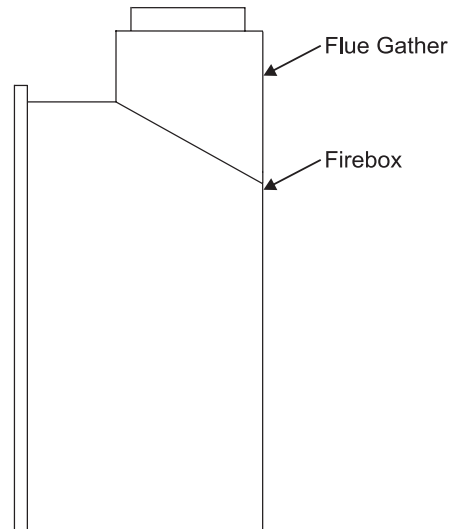



## VALVE TRAY INSTALLATION

- 1) Line up valve tray with 4 holes in firebox and secure with screws.      3) Place the valve shield over the valve and secure with screw.

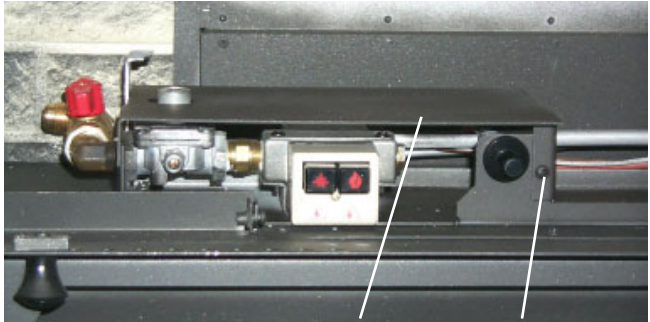

Valve Shield      Screw

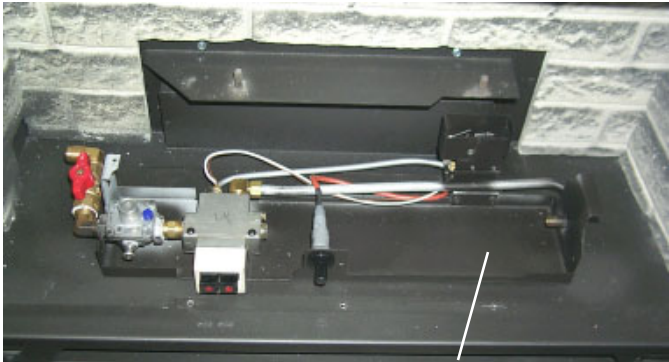

Secure valve tray  
with 4 screws.

- 2) Connect the unit to the gas line using a flex pipe.

- 4) Install the valve cover by aligning it with the 3 holes in the firebox and secure with screws.

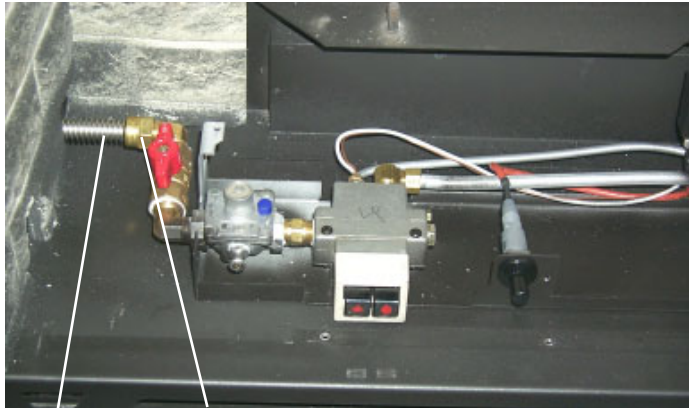

Flex Pipe      Gas Line

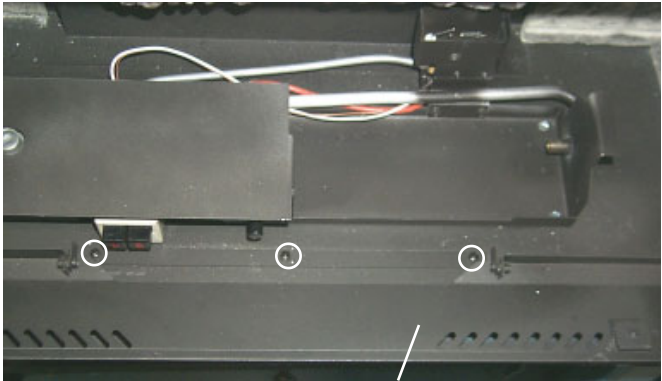

Valve Cover

# INSTALLATION

## BURNER INSTALLATION

1) Fit burner tube into orifice.

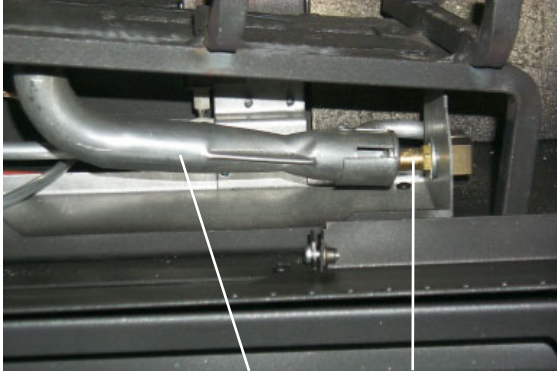

*Burner Tube Orifice*



*Secure burner to valve tray.*

2) Secure burner to the valve tray using one screw.

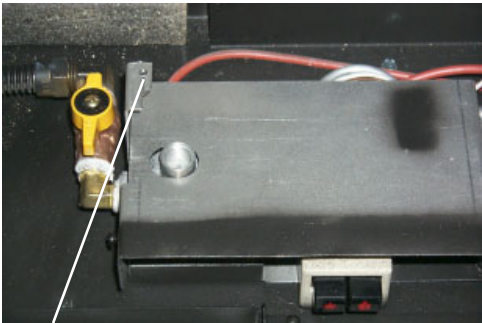

*Screw location in valve tray.*

3) Close valve cover.



*Valve Cover*

## LOG SET INSTALLATION

Carefully read the instructions below and refer to the diagrams. If logs are broken do not use the unit until they are replaced. Broken logs can interfere with the pilot operation.

The gas log kit (Part #390-930) contains the following pieces:

- |    |       |                  |         |
|----|-------|------------------|---------|
| a) | 02-55 | Middle Left Log  | 902-237 |
| b) | 02-52 | Middle Right Log | 902-240 |
| c) | 02-51 | Front Bottom Log | 902-241 |
| d) | 02-50 | Front Left Log   | 902-242 |
| e) | 02-95 | Rear Log         | 902-375 |
| f) | 02-96 | Center Left Log  | 902-376 |
| g) | 02-97 | Center Right Log | 902-377 |
| i) |       | Embers Lava      | 902-156 |

*The "02" reference numbers (i.e. 02-55) are moulded into the rear/bottom of each log.*

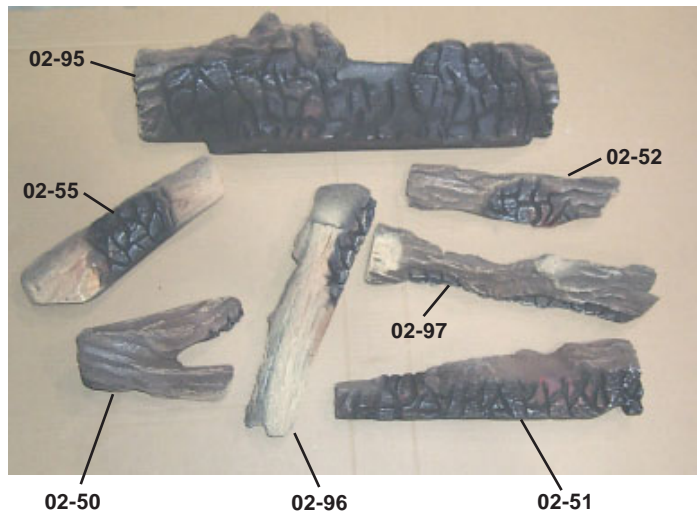

- Carefully remove the logs from the box and unwrap them. The logs are fragile, handle with care - **do not force into position**.
- Place Log 02-95 on the 2 rear log support pins with the flat side of the log to the back.

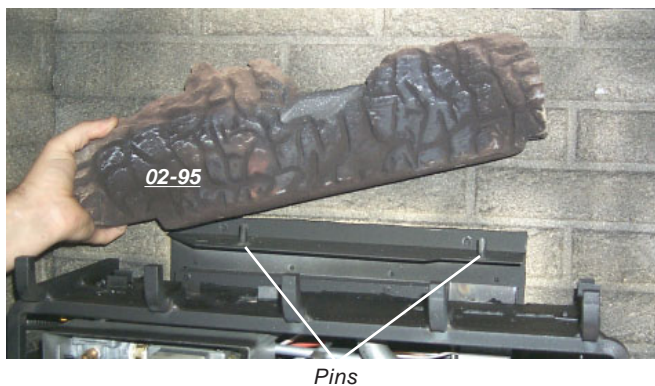

- Place Log 02-51 on the front right side of the burner. Push the back of the log against the 2 brackets with the notch on the bottom right side of the log fitting onto the side of the grate.

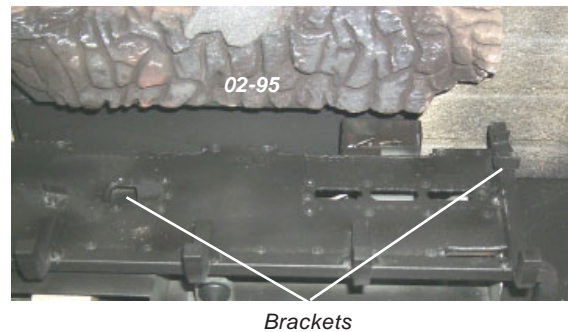

- Position Log 02-96 across the cutouts in Logs 02-95 and 02-51 with the notch on the bottom left side of the log fitting into the 2nd grate tab.

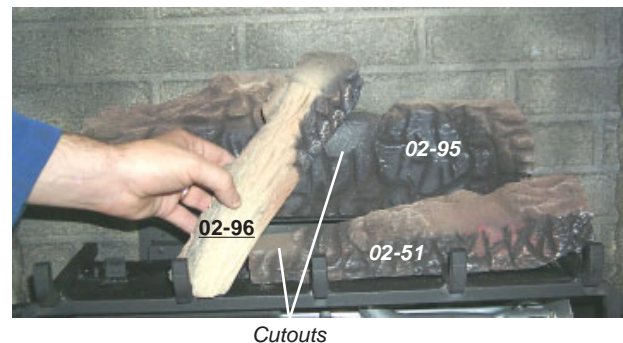



# INSTALLATION



Fit notch into 2nd grate tab.

- 5) Place the bottom left front edge of Log 02-55 against the rear bracket on the burner tray and rest the log on the cutout in Log 02-96.

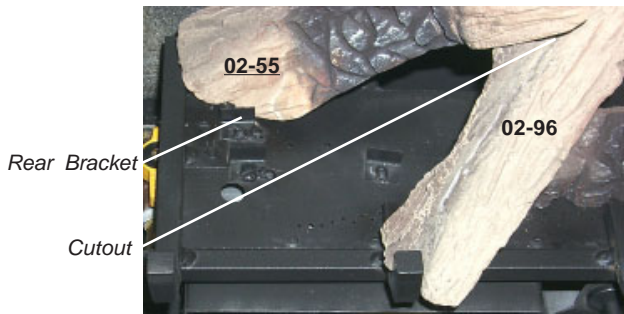

- 6) Sit Log 02-50 on the front left side of the burner. Push the back of the log against the 2 front brackets with the notch on the bottom of the log fitting onto the side of the grate.

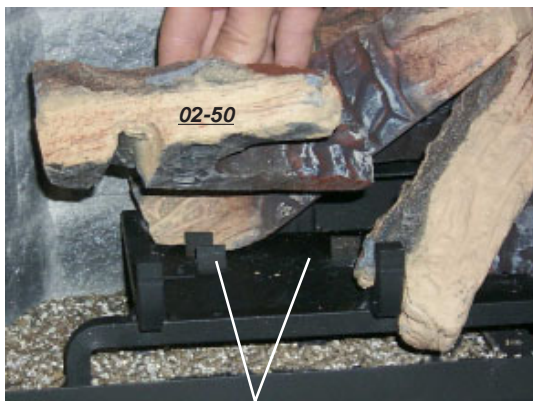

Front Brackets



Fit notch onto left side of grate.

- 7) Position Log 02-97 across the cutouts in Logs 02-51 and 02-96. Fit the notch in the bottom right end of the log against the 5th grate tab.

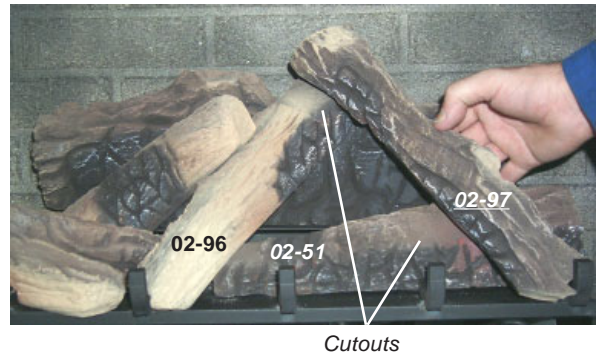

Cutouts



Fit notch into 5th grate tab.

- 8) Place Log 02-52 behind Logs 02-51 and 02-97 and rest the top end of the log on the cutout in Log 02-97. The bottom right end of the log goes behind the bracket at the back of the grate.



Bracket towards back of grate.

Photo shows rear of grate.

Log 02-51 was removed to show bracket.

# INSTALLATION

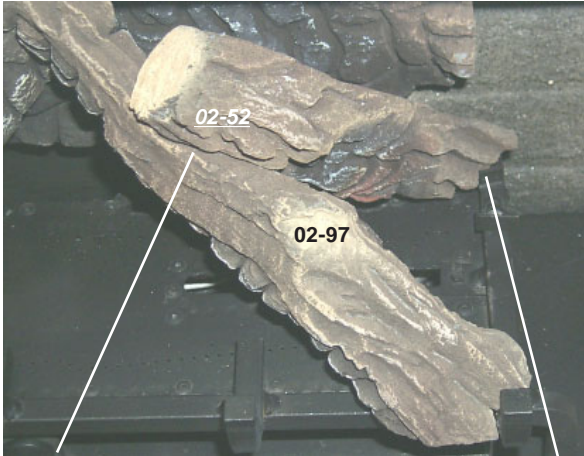

Cutout

Bracket

**Log 02-51 was removed to show placement of Log 02-52.**

- 9) Place the embers lava on the front of the burner tray as shown in the circled areas in the picture below.



Embers Lava

**Ensure not to block the burner ports.**

- 10) Test fire to ensure proper light off (make sure flame flows smoothly from one end of burner to the other). If there is any flame hesitation, check that area for any blockage of the burner ports.

- 11) Install screen door as per instructions in this manual.

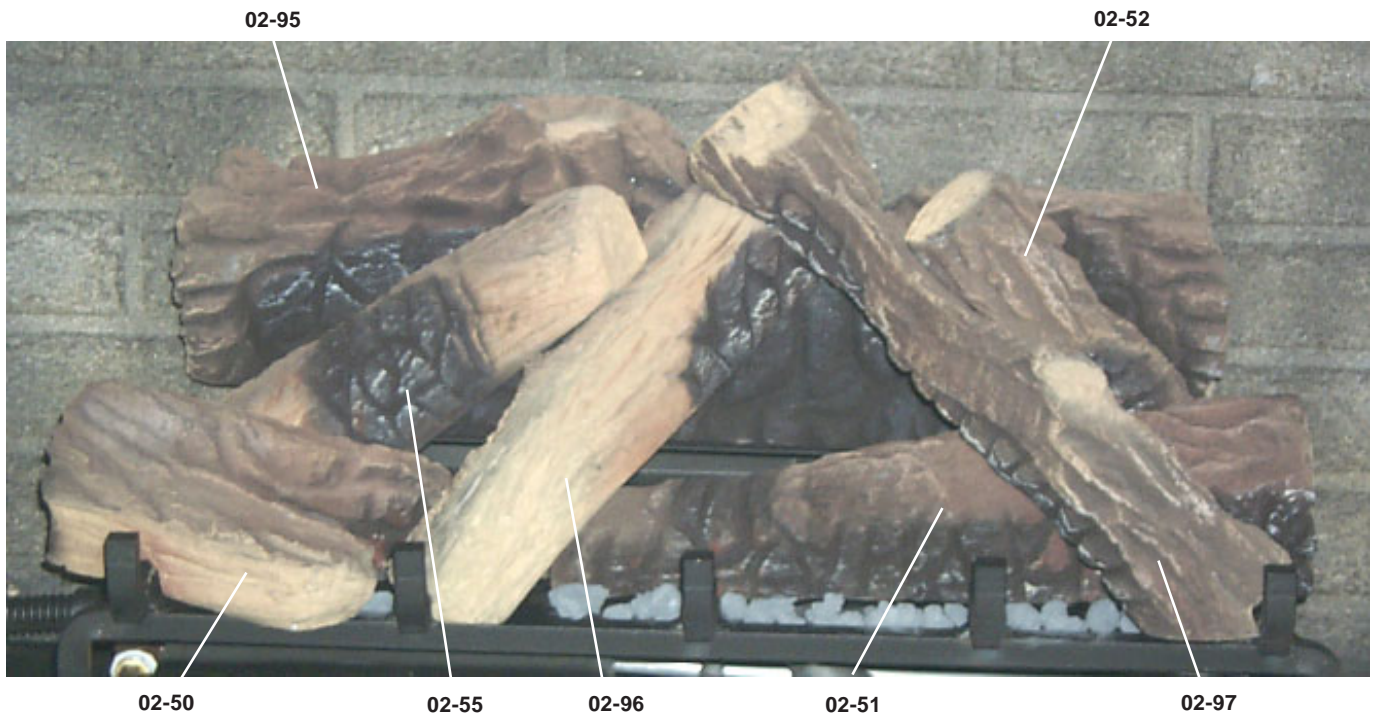



# INSTALLATION

## FINISHING TRIM INSTALLATION

- 1) Fit the left side finishing trim onto the firebox by sliding the cut-outs on the finishing trim through the screws on the side of the firebox.

Once trim is fitted in place, secure by tightening the 2 screws. Repeat for right side.



- 2) Fit top finishing trim onto firebox. Ensure cut-outs in trim lineup with screws on firebox.

Secure in place by tightening the 3 screws once fitted in place.

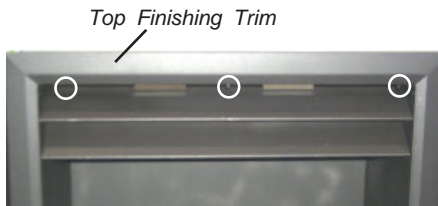

## BRICK PANEL INSTALLATION

- 1) Remove screen door, if used.
- 2) Carefully unwrap the brick panels from the protective wrapping.

**NOTE: The logs must not be in the unit.**

- 3) Insert the back brick panel first by carefully slipping it between the back wall of the firebox and rear log brackets.

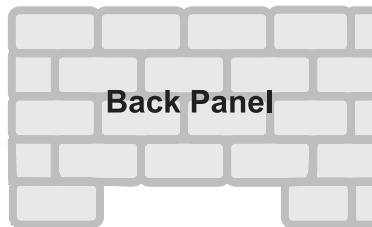

- 4) Slide the side panels in from the front and push them flat up against the wall. Be very careful not to scratch them on the firebox hardware.

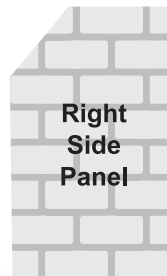
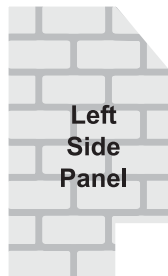

- 5) Install the brick retaining clips, one on each side to secure the side brick panels in place.

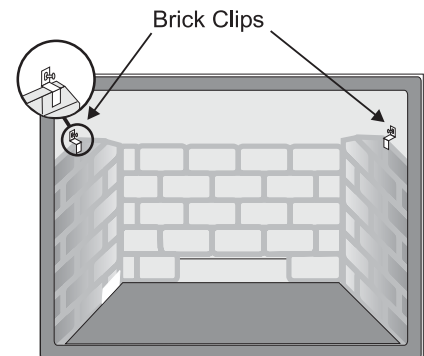
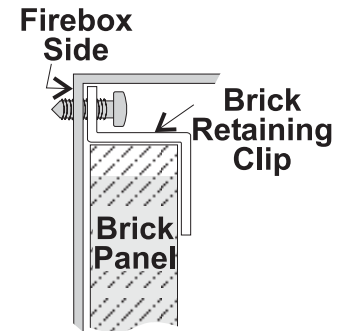

- 6) Re-install screen door, if used.

## OPTIONAL SCREEN INSTALLATION

1) Install the 3 brackets as shown.

### Top Left Bracket:

Secure the top left bracket to the top left side of the louver using 2 screws.

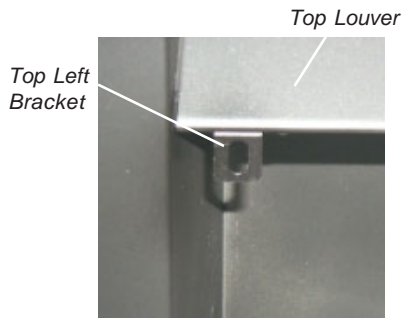

2) Fit the pin on top of the screen into the pin hole located in the top right bracket.

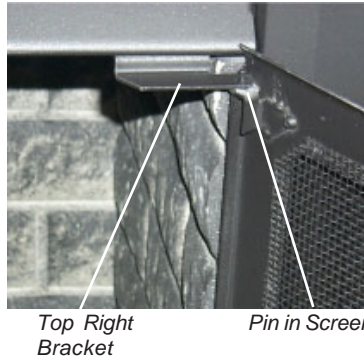

3) Pull up the spring loaded pin at the bottom of the screen and rest it in the pin hole of the bottom right bracket.

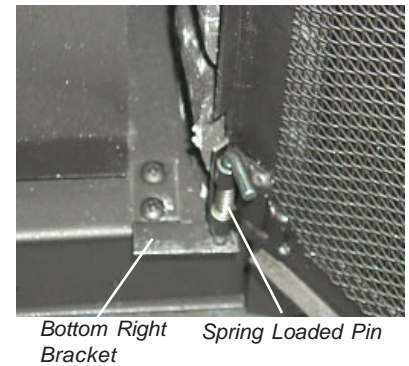

### Top Right Bracket:

Secure the top right bracket to the top right side of the louver using 2 screws.

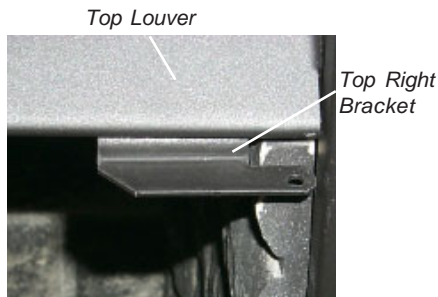

### Bottom Right Bracket:

Secure the bottom right bracket to the bottom right side of the firebox using 2 screws.

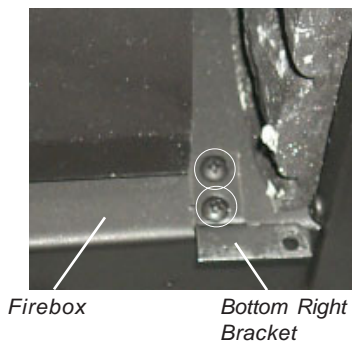

# INSTALLATION

## WIRING

This heater does not require a 240V A.C. supply for the gas control to operate. A 240V A.C. power supply is needed for the fan/blower operation.

**Caution: Ensure that the wires do not touch any hot surfaces and are away from sharp edges.**

**CAUTION: Label all wires prior to disconnection when servicing controls. Wiring errors can cause improper and dangerous operation.**

**WARNING: Electrical Grounding Instructions**  
This appliance is equipped with a three pronged (grounding) plug for your protection against shock hazard and should be plugged directly into a properly grounded three-prong receptacle. Do not cut or remove the grounding prong from this plug.

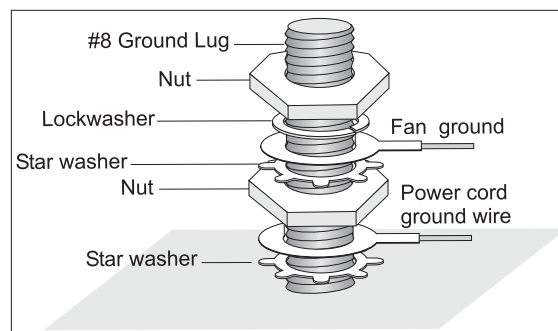
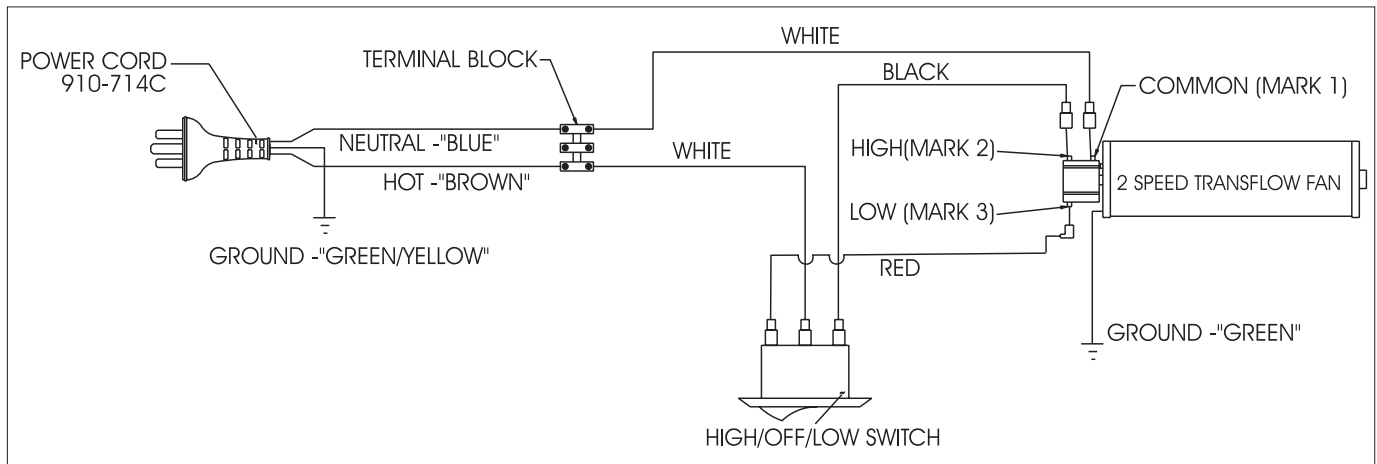



# OPERATING INSTRUCTIONS

## OPERATING INSTRUCTIONS

Before operating this appliance, proceed through the following check list.

- 1) Read and understand these Instructions before operating this appliance.
- 2) Check to see that all wiring is correct and enclosed to prevent possible shock.
- 3) Check to ensure there are no gas leaks.
- 4) Verify that all flueing and the cap is unobstructed.
- 5) Verify log placement. If the pilot cannot be seen when lighting the unit - the logs or the embers have been incorrectly positioned.
- 6) The unit should never be turned off and on again without a minimum wait of 60 seconds.

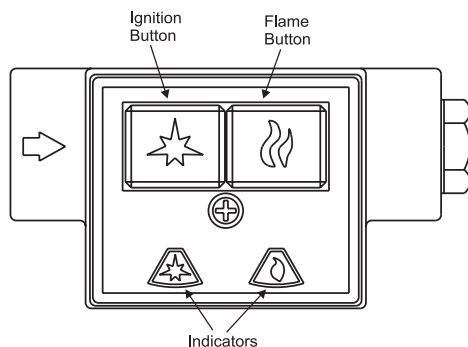

## LIGHTING PROCEDURE

- 1) Remove screen door.
- 2) Open valve cover.
- 3) Turn ON the shut off valve.



Shut off Valve

- 4) Fully press the ignition button and ignite the pilot burner by continuously depressing the piezo ignitor. Once the pilot has lit, continue holding in the ignition button for approximately 10 seconds to ensure the pilot stays on. If it goes out, wait 1 minute and repeat the ignition operations.

### Normal Operation:

Depress the ignition button again to ignite the burner.

### Flame Selection:

Press the flame button for the flame adjustment. For minimum flame, depress the button. For maximum flame, release the button.

### Pilot Position:

Depress the ignition button to turn off the burner flame. The indicator should show the ignition symbol.

- 5) Close valve cover.

- 6) Install screen door.

## SHUTDOWN PROCEDURE

Turn OFF the shut off valve to shut down the pilot and burner.

Always install screen door during operation to reduce risk of injury.

## FIRST FIRE

The first fire in your stove is part of the paint curing process. To ensure that the paint is properly cured, it is recommended that you burn your fireplace for at least four (4) hours the first time you use it with the fan on. When first operated, the unit will release an odour caused by the curing of the paint, the burning off of any oils remaining from manufacturing. Smoke detectors in the house may go off at this time. Open a few windows to ventilate the room for a couple of hours.

## NORMAL OPERATING SOUNDS OF GAS APPLIANCES

It is possible that you will hear some sounds from your gas appliance. This is perfectly normal due to the fact that there are various gauges and types of steel used within your appliance. Listed below are some examples. All are **normal operating sounds** and should not be considered as defects in your appliance.

### Blower:

Masport gas appliances use high tech blowers to push heated air farther into the room. It is not unusual for the fan to make a "whirring" sound when ON. This sound will increase or decrease in volume depending on the speed setting of your fan speed control.

### Burner Tray:

The burner tray is positioned directly under the burner tube(s) and logs and is made of a different gauge material from the rest of the firebox and body. Therefore, the varying thicknesses of steel will expand and contract at slightly different rates which can cause "ticking" and "cracking" sounds. You should also be aware that as there are temperature changes within the unit these sounds will likely re-occur. Again, this is normal for steel fireboxes.

### Blower Thermodisc:

When this thermally activated switch turns ON it will create a small "clicking" sound. This is the switch contacts closing and is normal.

### Pilot Flame:

While the pilot flame is on it can make a very slight "whisper" sound.

### Gas Control Valve:

As the gas control valve turns ON and OFF, a dull clicking sound may be audible, this is normal operation of a gas regulator or valve.

### Unit Body/Firebox:

Different types and thicknesses of steel will expand and contract at different rates resulting in some "cracking" and "ticking" sounds will be heard throughout the cycling process.

# OPERATING INSTRUCTIONS

## COPY OF LIGHTING PLATE INSTRUCTIONS

### FOR YOUR SAFETY READ BEFORE LIGHTING

This appliance must be installed in accordance with local codes, if any; if not, follow current CAN1-B149/ANSI Z223.1 Australia: AG 601/New Zealand: NZS 5261.

**WARNING:** If you do not follow these instructions exactly, a fire or explosion may result causing property damage, personal injury or loss of life. Improper installation, adjustment, alteration, service or maintenance can cause injury or property damage. Refer to the owner's information manual provided with this appliance. For assistance or additional information consult a qualified installer, service agency or gas supplier.

- A) This appliance has a pilot which must be lighted by hand. When lighting the pilot, follow these instructions exactly.
- B) **BEFORE LIGHTING** smell all around the appliance area for gas. Be sure to smell next to the floor because some gas is heavier than air and will settle on the floor.

#### WHAT TO DO IF YOU SMELL GAS

- Do not try to light any appliance
  - Do not touch any electric switch, do not use any phone in your building
  - Immediately call your gas supplier from a neighbours phone. Follow the gas supplier's instructions.
  - If you cannot reach your gas supplier, call the fire department.
- C) Use only your hand to push in or turn the gas control knob. Never use tools. If the knob will not push in or turn by hand, don't try to repair it, call a qualified Service technician. Force or attempted repair may result in a fire or explosion.
  - D) Do not use this appliance if any part has been under water. Immediately call a qualified service technician to inspect the appliance and to replace any part of the control system and any gas control which has been under water.

This appliance needs fresh air for safe operation and must be installed so there are provisions for adequate combustion and ventilation air.

**CAUTION:** Hot while in operation. Do not touch. Severe Burns may result. Due to high surface temperatures keep children, clothing and furniture, gasoline and other liquids having flammable vapors away. Keep burner and control compartment clean. See installation and operating instructions accompanying appliance.

### LIGHTING INSTRUCTIONS

**STOP!** Read the safety information above on this label.

- 1) Remove screen door, if used.
- 2) Open valve cover.
- 3) Turn ON the shut off valve.
- 4) Fully press the ignition button and ignite the pilot burner by continuously depressing the piezo ignitor. Once the pilot has lit, continue holding in the ignition button for approximately 10 seconds to ensure the pilot stays on. If it goes out, wait 1 minute and repeat the ignition operations.

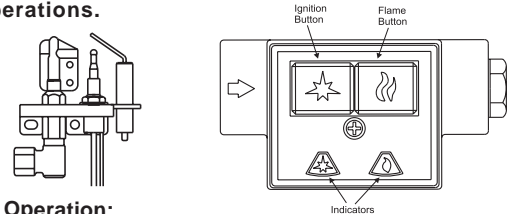

#### Normal Operation:

Press and release the ignition button again to ignite the burner.

#### Flame Selection:

Press the flame button for the flame adjustment. For minimum flame, depress the button. For maximum flame, release the button.

#### Pilot Position:

Press and release the ignition button to turn off the burner flame. The indicator should show the ignition symbol.

- 5) **Close valve cover.**
- 6) **Install screen door, if used.**

### TO TURN OFF GAS APPLIANCE

Turn OFF the shut off valve to shut down the pilot and burner.  
Always install screen door during operation to reduce risk of injury.

*You may shut off the pilot during prolonged non use periods to conserve fuel.* 918-249

**DO NOT REMOVE THIS INSTRUCTION PLATE**

**ANY SERVICING OR REPAIRS  
SHOULD BE CARRIED OUT ONLY BY AN  
AUTHORISED PERSON.**

## MAINTENANCE INSTRUCTIONS

- 1) Always turn the gas valve off before cleaning. For relighting, refer to lighting instructions. Keep the burner and control compartment clean by brushing and vacuuming at least once a year.

When cleaning the logs, use a clean soft paint brush as the logs are fragile and easily damaged.

- 2) Clean (never when unit is hot) appliance, door and louvres with a damp cloth. Never use an abrasive cleaner.

The heater is finished in a heat resistant paint and should only be refinished with heat resistant paint (not with wall paint). Masport uses StoveBrite Paint - Metallic Black #6309.

- 3) Make a periodic check of burner for proper position and condition. Visually check the flame of the burner periodically, making sure the flames are steady; not lifting or floating. If there is a problem, call an authorised service person.

- 4) The appliance and flueing system must be inspected before use, and at least annually, by an authorised field service person, to ensure that the flow of combustion and ventilation air is not obstructed.

During the annual service call, the burners should be removed from the burner tray and cleaned. Replace the embers but do not block the pilot.

- 5) Keep the area near the appliance clear and free from combustible materials, gasoline and other flammable vapours and liquids.

**WARNING: CHILDREN AND ADULTS SHOULD BE ALERTED TO THE HAZARDS OF HIGH SURFACE TEMPERATURE AND SHOULD STAY AWAY TO AVOID BURNS OR CLOTHING IGNITION. YOUNG CHILDREN SHOULD BE CAREFULLY SUPERVISED WHEN THEY ARE IN THE SAME ROOM AS THE APPLIANCE.**

**CAUTION: ANY SAFETY SCREEN OR GUARD REMOVED FOR SERVICING AN APPLIANCE MUST BE REPLACED PRIOR TO OPERATING THE APPLIANCE.**

**CLOTHING OR OTHER FLAMMABLE MATERIAL SHOULD NOT BE PLACED ON OR NEAR THE APPLIANCE.**

- 6) Verify proper operation after servicing.
- 7) Periodically check the pilot flames, there should be two strong blue flames approx. 3/4" long - 1 flame to the front burner, and 1 to the thermocouple. See diagrams below.

**Correct flame pattern has two strong blue flames: 1 flowing around the thermocouple and 1 reaching towards the rear burner (it does not have to be touching the burner).**

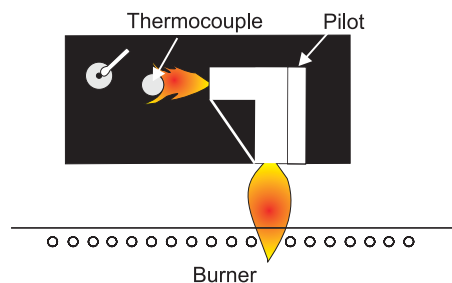

Top View of pilot flame

**Incorrect flame pattern will have small, probably yellow flames, not coming into proper contact with the rear burner or thermocouple.**

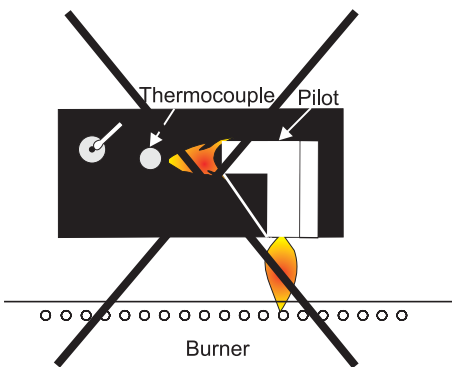

Top View of pilot flame

If you have an incorrect flame pattern, contact your Masport dealer for further instructions.

**WARNING**  
Do not spray aerosols in the vicinity of this appliance while in operation.

## LOG REPLACEMENT

The unit should never be used with broken logs. Turn off the gas valve and allow the unit to cool, carefully remove the logs. The pilot light generates enough heat to burn someone. If for any reason a log should need replacement, you must use the proper replacement log. The position of these logs must be as shown in the diagrams under Log Set Installation.

**NOTE: Improper positioning of logs may create carbon build-up and will alter the unit's performance which is not covered under warranty.**

# MAINTENANCE

## FAN REPLACEMENT

- 1) Shut off power supply.
- 2) Remove screen door.
- 3) Remove logs.
- 4) Remove burner.
- 5) Remove brick panels.
- 6) Remove the 2 screws which secure the rear log tray.

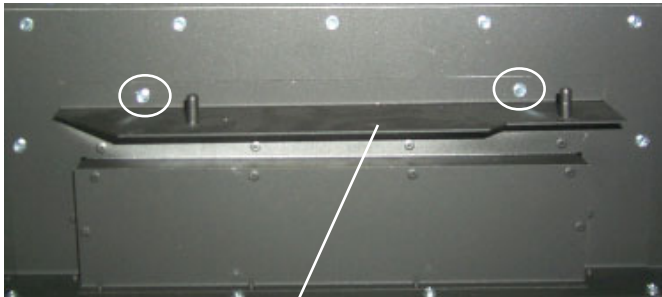

Rear Log Tray

- 7) Remove the fan cover plate by undoing the 11 screws and carefully lift out.

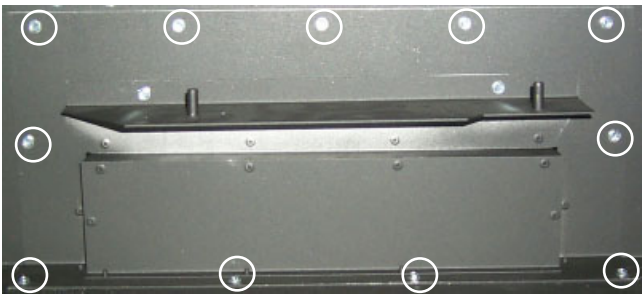

- 8) Remove the fan deflector by undoing the 3 screws (2 on the left and 1 on the right).



Fan Deflector

- 9) Partially lift out fan.

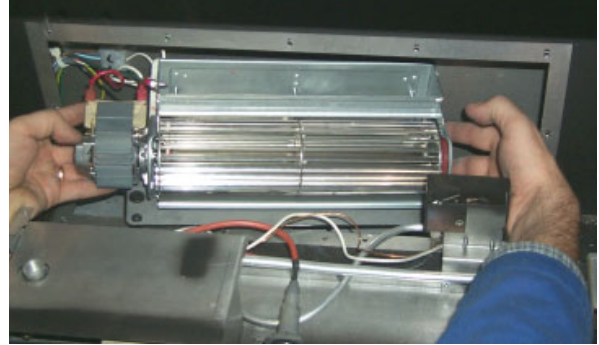

- 10) Disconnect the ground wire.

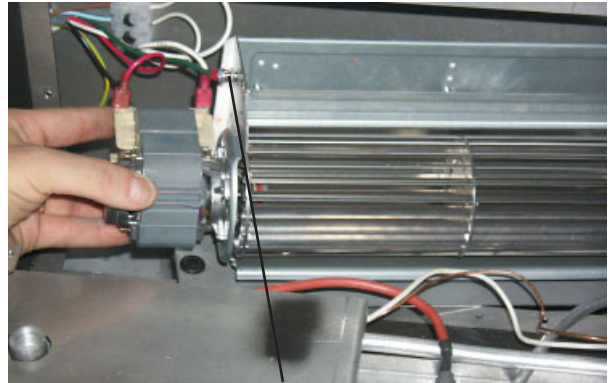

Ground Wire

- 11) Disconnect the 3 connector wires.

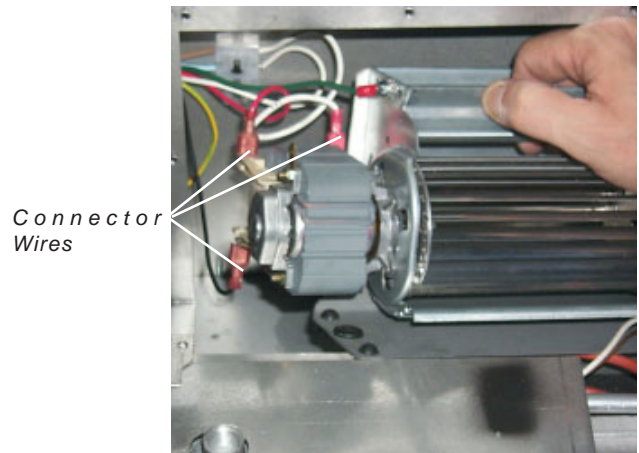

Connector Wires

- 12) Reverse steps 10 to 6 to install new fan.

- 13) Re-install brick panels, burner, logs and screen door as per instructions in this manual.

# REPLACEMENT PARTS

---

Part #	Description
390-033	HoodPilot
390-510/P	Valve Assembly - NG
390-511/P	Valve Assembly - LPG
390-525	Burner Assembly - NG/LPG
511-031	Clip Brick
560-519/P	Fan Assembly
390-000	Grate Assembly
390-930	Log Set
904-258	Magnet Ceramic
904-658	Inlet Flex Line Gas E61
904-777	Orifice #29 NG
904-652	Orifice #46 LPG
908-227	Label Blower Emerald Insert
910-006	Terminal Block 3 Pole
910-053	Regulator NG RV20LSF-33 W/PF10
910-054	Regulator LPG
910-090	Valve NG Simploit 0.500.017
910-091	Valve Simploit LPG
910-092	Pilot Assembly Oxypilot NG 9058
910-093	Pilot Assembly Oxypilot LPG
910-094	Cable Ignition
910-095	Knob Push/Pull 10-32
910-140	Switch 3 Way Carling
910-169/P	Fan 240V Transflow 2 Speed
910-190	Peizo Ignitor Push Button Black
910-692	Wire Fan to Power Cord Ground
910-714	Power Cord 240V
910-731	Wire Fan to Terminal Block
910-900	Wire Fan to Switch
918-257	Manual
918-249	Lighting Instruction Decal
948-218	Logo Plate Masport





## THE MASPORT EXPRESS WARRANTY

All new Masport Gas appliances are warranted, subject to the following conditions, to be free from defects in material or workmanship under normal use. The Express Warranty on all parts, including firebox components but excluding fans, flues and flue accessories is two years from date of original purchase as well as labour costs involved in the repair or replacement. The Express Warranty on fans, flues and accessories is for a period of twelve months from date of original purchase and includes labour costs involved in the repair or replacement.

This Express Warranty applies only with respect to defects in material and workmanship under normal and proper use of the NEW UNIT in its unmodified condition. Masport's obligation under this Express Warranty is limited to the repair or replacement, at its option, by an approved Masport Gas Service Agent (Retailer) of any part found to be defective in material or workmanship.

Labour costs involved in the repair or replacement are also covered under this Express Warranty as per the time condition outlined.

If an approved Masport Gas Service Agent is requested to attend on a service call that is not covered under this Express Warranty, a call out charge may be applicable, regardless of whether a repair is carried out or not.

Masport can accept no obligation whatsoever for any incidental, consequential or special damages or expenses resulting from any product defect. This Express Warranty applies from the date of original purchase, applies to the original purchaser, and is not transferable. The decision to repair or replace defective components will be made by Masport or its agent and actioned by an approved Masport Service Agent.

### This Express Warranty Does Not Cover:

1. Defects, malfunctions or failures caused by incorrect installation, normal wear and tear, misuse, neglect, accidental damage or failure to follow the fuel selection, product operating and maintenance instructions, or resulting from installations, repairs or modifications to the equipment carried out by unauthorised persons.
2. Defects, malfunctions or failures caused by an act or omission of other persons after the product has left Masport's control.
3. The costs of collection and delivery of the equipment.
4. The cost of labour or materials as a consequence of faulty installation of gas supply line, flue, burner or log settings, or non-compliance with local codes.

**The Express Warranty is not intended to exclude any rights the purchaser may have under the laws of the place, state, or country of purchase. Nothing in this Express Warranty limits or restricts any other statutory right or remedy available to the purchaser.**

### How You Obtain Warranty Service:

Provide proof of the date of purchase. Should the need for a warranty claim arise reasonable proof of the purchase date is required therefore you should retain your sales receipt. Where flueless appliances are not permanently installed, they should be returned to a Service Agent for evaluation.

Make the faulty part(s) available for inspection by Masport and/or its agents so that the validity of the claim can be established by them.

---

#### Australia Distributor:

Masport Pty Limited  
P.O. Box 533  
Braeside Victoria 3195

#### New Zealand:

Masport Limited  
P.O. Box 14-349  
Panmure  
Auckland 6

---

For your own records, please complete the following:

Model: _____	Serial Number: _____
Retailer: _____	
_____	
Purchase Date: _____	

